

Working Paper Sustainability and Innovation
No. S 02/2021



Verena Sauter
Daniel Speth
Patrick Plötz
Tim Signer

A charging infrastructure network for battery
electric trucks in Europe

Abstract

Facing climate change, The European Union has set ambitious greenhouse gas (GHG) reduction targets. Within Europe, heavy-duty vehicles (HDV) account for a quarter of greenhouse gas emissions in the transport sector and therefore plays a central role in achieving the climate targets. A potential solution to reduce GHG emissions is the use of battery electric vehicles (BEV). However, the limited range of BEV requires a European public fast-charging network to ensure widespread deployment of BEV. Here, European road freight transport flows are modelled based on the publicly available European Transport policy Information System (ETISplus) dataset. The resulting truck flows serve as input for a charging infrastructure network model. Potential charging stations are located using a coverage-oriented approach and sized according to a queuing model such that an average waiting time of five minutes is guaranteed at each location. Our results show that for a share of 15% BEV in HDV stock and a dense network with charging locations every 50 km, a total of 4,067 charging points at 1,640 locations are required by 2030. In contrast, with a share of 5% BEV and charging locations every 100 km, 1,715 charging points are needed at 812 locations. Our findings provide insights for the design of a public fast-charging network in Europe and thus supports the planning of future infrastructure projects.

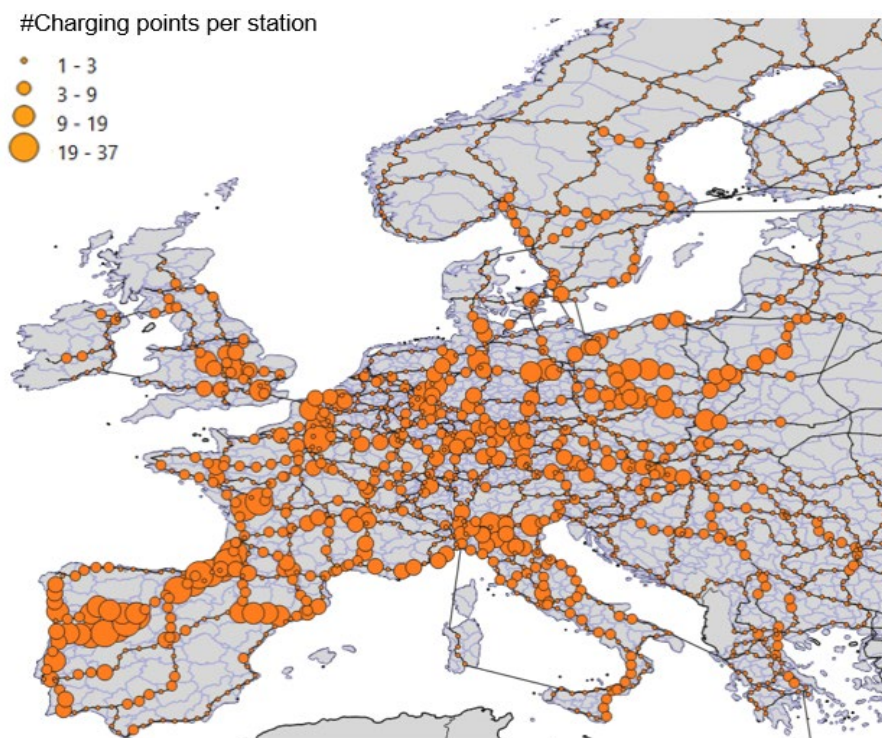

Figure 1: Distribution and size of fast-charging stations in the “close mesh network”

| Table of Content | Page |
|--|-------------|
| 1 Introduction..... | 1 |
| 1.1 Literature review | 2 |
| 2 Data and Methods | 3 |
| 2.1 Data | 3 |
| 2.1.1 Database..... | 3 |
| 2.1.2 Data calibration | 3 |
| 2.2 Methods | 6 |
| 2.2.1 Traffic flow model | 6 |
| 2.2.2 Charging infrastructure..... | 8 |
| 3 Results..... | 13 |
| 3.1 Traffic flow analysis..... | 13 |
| 3.2 Charging infrastructure networks | 15 |
| 4 Discussion..... | 23 |
| 5 Conclusion and outlook | 24 |
| 6 References..... | 25 |

1 Introduction

To achieve the climate targets, set by the EU Commission in the European Green Deal, a comprehensive transformation of the transport sector toward zero-emission vehicles is required. Within the EU, transport is responsible for a quarter of total greenhouse gas emissions, with trucks and other heavy-duty vehicles accounting for 26% (Eurostat 2020b). The EU Commission therefore set a target of at least 80.000 zero-emission trucks by 2030 and a majority of zero-emission trucks by 2050 for European road transport (Europäische Kommission 2020). However, according to estimates by automotive manufacturers, for 2030 the number of battery-electric trucks in the EU could be three to six times higher (ACEA and Transport & Environment 2021). The goal of widespread use of battery-electric trucks can only be achieved through intensive expansion of the associated infrastructure. In this regard, network effects between the development of charging infrastructure and the demand for electric vehicles can be demonstrated (Li et al. 2017).

Studies show that the availability of fast-charging infrastructure is essential for the competitiveness of battery electric trucks compared to diesel engines (Transport & Environment 2021; Nykvist und Olsson 2021). However, in its report on the Alternative Fuels Infrastructure Directive (AFID), the European Commission states that so far the implementation of the requirements in the EU is not sufficient to result in a comprehensive and complete network of charging infrastructure for battery electric vehicles (Europäische Kommission 2021).

Experts from science, politics and industry are therefore calling for concrete solution concepts from the EU at the level of all European member states (ACEA 2020; Plötz et al. 2021). When planning such charging infrastructure projects, the selection of suitable locations for the fast-charging stations based on the modeling of traffic flows plays a central role in order to enable an economic realization.

The aim of our is twofold. On the one hand, the truck traffic flows in Europe are to be analyzed in more detail to identify central corridors for the charging infrastructure. Secondly, a coverage approach will be used to identify possible locations for a public charging infrastructure throughout Europe based on the transport flows forecast for the year 2030. In addition to the geographic location, a queuing model is then used to determine the number of charging points for each station.

1.1 Literature review

Most studies on electrified powertrains have focused on analyzing potential charging infrastructure for electric passenger cars (Madina et al. 2016; Morrissey et al. 2016; Wang et al. 2017). The majority of these studies examine smaller geographic areas, with only a few studies defining charging infrastructure for the whole European road network (Jochem et al. 2019).

In the area of heavy-duty vehicles existing studies are largely limited to short-haul urban freight transport (Teoh et al. 2018) or urban bus systems (Xyllia et al. 2017; Kunith et al. 2017) when analyzing potential charging locations. However, studies on the diffusion of alternative drives emphasize the need for infrastructure that covers a wide area (Li et al. 2017). Transport & Environment attempt to fill this gap with their analysis of European freight transport and a forecast for a fast-charging infrastructure all over Europe (Transport & Environment 2020). In addition, the TRIMODE model, contracted by the European Commission, aims to combine the simulation of transport-, economic- and energy-systems to enable the assessment of large transport infrastructure projects (TRT 2020)

Numerous optimization algorithms and heuristics can be used to model location problems. One possibility is the coverage approach, which aims to distribute the charging locations as evenly as possible. This can guarantee a high geographical coverage, regardless of whether a road is heavily traveled or not (Reuter-Oppermann et al. 2017). Within the coverage approach, charging locations are placed at a predefined distance from each other along the road network. In contrast to demand-driven algorithms, no optimization regarding the utilization of the charging points takes place. Reuter-Oppermann et al. use the coverage approach to analyze the required car charging stations along the German autobahn network, and Plötz et al. complement this approach with their study on truck charging points (Reuter-Oppermann et al. 2017; Plötz et al. 2020).

For the design of a charging infrastructure, the number of required charging points at each location is important in addition to the geographic placement of the charging stations. The number of required charging points can be calculated with the help of a queuing model. This approach has already been used to determine cost efficient infrastructure for electric cars (Zhu et al. 2018) and has also been validated using real-world data (Liang et al. 2014).

2 Data and Methods

2.1 Data

2.1.1 Database

The data used to develop the traffic model are based on the results of the European Transport policy Information System (ETIS). ETISplus 2010 represents an extension of its predecessor project, which ended in 2005, and to date provides one of the most comprehensive surveys of European transport (European Commission 2013). Within the international project, a common database was created, which is still used today by numerous modelers and policy makers to analyze European transport (Szimba et al. 2012).

The origin- destination *Road Freight Matrix* within the dataset serves as the data basis for modeling transport flows (ETISplus 2012a). Numerous transport data tables from Eurostat, as well as national databases, were used within the ETISplus project to generate the origin-destination matrix (O-D matrix). The dataset maps the transported goods volumes between the NUTS-3 regions of the EU. The NUTS-3 classification represents a geographical system within which the territories of the European Union are divided. This classification enables cross-border comparison of individual regions (Statistisches Bundesamt 2021). There is a high variation in the size of the NUTS-3 regions between different countries. The quantities of goods transported are specified in tons and are broken down by goods classifications.

In addition to transport volumes, ETISplus also provides a database on the European road network in order to be able to map traffic flows onto a road network (ETISplus 2012b). This database contains detailed information on individual road sections and their connection points. The *RoadLink* table contains road data, such as the start and end point, as well as the length and road type of a road section. In addition, information on the nodes of the road network can be obtained from the *RoadNode* table.

2.1.2 Data calibration

The ETISplus data set contains transport flows from the year 2010. This data needs to be updated to represent current traffic flows and to calculate the charging infrastructure required in the future. The following describes how the data is first scaled up to current numbers from 2019 and then projected to 2030.

The O-D matrix of the ETISplus dataset is based on transport volume data collected by Eurostat. To achieve the highest possible consistency, the scaling is also based on these data tables. For the representation of national transport flows, the two tables *road_go_na_rl3g* and *road_go_na_ru3g* are relevant (Eurostat 2020a). In the *road_go_na_rl3g* dataset, annual national transports are broken down by the respective NUTS-3 regions in which the goods were loaded. The transport volumes are given in 1,000 tons. The *road_go_na_ru3g* dataset shows the same transport flows but breaks down the national transport quantities into the individual unloading regions. However, the data for individual years and countries are not available in the tables and therefore cannot be directly adopted for the upscaling. Therefore, a growth factor based on aggregated national and international transport flows is calculated, which is used to adjust the ETISplus values from 2010 to 2019. An overview about the Eurostat data tables that had been used to calculate the growth rates can be found in figure 2.

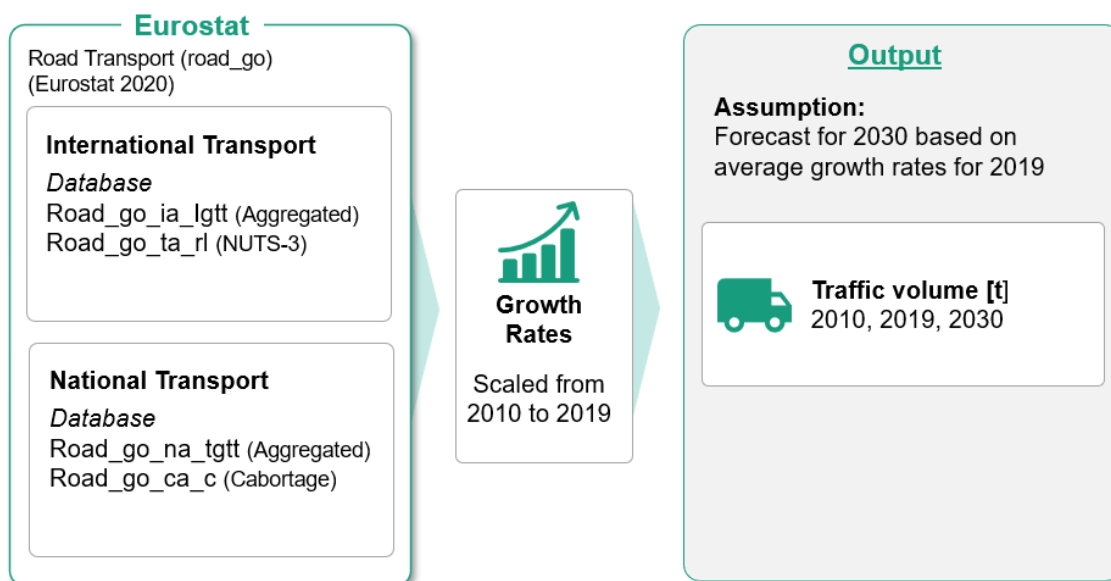

Figure 2: Graphical representation of the data used to scale the traffic flows

To calculate the national growth rate the current value from 2019 is taken from the *road_go_na_tgtt* table in Eurostat. The table contains the annual national transport volume of a country. These transport volumes are additionally supplemented by the annual road cabotage from the Eurostat table *road_go_ca_hac*. Road cabotage is the transport of goods by a vehicle regis-

tered in one country, carried out in the national territory of another country (Eurostat 2014).

From the aggregated transport volumes, an average growth rate is calculated using formula (1) for each of the EU28 countries, England, Norway, and Switzerland, as data is only provided by Eurostat for these countries. The growth rate corresponds to the relative change in the transport volume of the individual countries compared to the previous value from the year 2010 (Hüpen 2002).

$$(1) \text{ Average growth rate } \bar{p} = \left(\frac{X_n}{X_0}\right)^{\frac{1}{n}} - 1$$

$$\text{Here : } \bar{p}_{\text{country } i} = \left(\frac{X_{i,2019}}{X_{i,2010}}\right)^{\frac{1}{9}} - 1$$

$\bar{p}_{\text{country } i}$ Average growth rate in country i

$X_{i,2019}$ Aggregated transport volume in country i in year 2019

$X_{i,2010}$ Aggregated transport volume in country i in year 2010

The resulting country-specific growth rates are then applied to all national transportation flows in ETISplus at the NUTS-3 level using formula (2) to obtain updated values for 2019.

$$(2) \text{ Scaled value } X_n = (1 + \bar{p})^n * X_0$$

$$\text{Here: } X_{i,2019} = (1 + \bar{p}_i)^9 * X_{i,2010}$$

To calculate the growth rates for the international transport flows, the growth rates of the exports of all EU28 countries, England, Norway, and Switzerland are considered. Since the growth rates of exports (3.7%) and imports (3.64%) hardly differ from each other, the export growth factor is used to scale all international transport flows. Due to the large number of missing values, the growth rate can only be calculated for half of the countries from the export flows provided at NUTS-3 level (*road_go_ta_rl*). For those countries where the data set contains too many values that are not available in Eurostat, the aggregated exports from the table *road_go_ia_lggt* are used.

To be able to analyse the charging infrastructure required in the future, the current traffic flows must be projected to the year 2030. Since no clear values can

be found in the literature, it is assumed that the countries will continue to grow between 2019 and 2030 with the same growth rates as between 2010 and 2019. This results in a growth rate of transport volumes within the EU of 25% between 2019 and 2030.

In the final step the transport volume is converted to individual truck trips using loading factors to model traffic flows. In 2010 according to the European Commission, the average loading factor was 13.6 tons. This value remained constant between 13 and 14 tons in subsequent years (European Commission 2011). Eurostat provides a detailed breakdown of the loading factors of individual countries for 2018. From these country-specific data, the average loading factor for the EU is 13.65 tons (Eurostat 2019). Based on the constant developments of the loading factor in the EU described above, an average value of the loading factors of 13.6 tons for the years 2010, 2019 and 2030 is assumed for the calculation of the transport flows.

In addition to the EU28 countries, England, Norway, and Switzerland, the ETISplus dataset also includes other countries on the European continent that are not EU member states. Import and export volumes of these countries correspond to only 0.118% of the total ETISplus transport volume. Since no values are available in Eurostat for these countries, the average growth rate of 25% is assumed in the corresponding cases. At the end of the data preparation process, an O-D matrix with transport flows and the corresponding transport volumes for the years 2010, 2019 and 2030 is available.

2.2 Methods

2.2.1 Traffic flow model

The analysis of routing and network problems has been the focus of numerous studies, where a graph representation is often used to analyze a road network. A graph is defined by the specification of nodes, edges, and their associated attributes (Ben Ticha et al. 2017). To develop a traffic flow model such a graph representation is modeled using the Python package *NetworkX*.

The ETISplus table *Road Node* contains the relevant information to describe the nodes and the *Road Link* table to define the edges. Using all network elements defined in the ETISplus dataset results in a very complex, disjointed road network with numerous edges. To lower complexity, the network is reduced to road sections that are part of a highway or the international E-road network. The E-

road network includes the main roads of international traffic on the European continent, which is why the reduction preserves the informative value of the model. Due to missing road segments or wrong classifications of roads in the dataset, the modeled graph is neither complete nor coherent. To ensure that all E-roads are part of the final graph, the connections of all European roads are checked, and the missing edges are manually added. At the end of the network optimization, a network graph is available as a model of the highways and E-roads in Europe. The graph consists of 17,435 nodes, 18,447 edges, and in addition to coordinate data and road classifications, the graph contains distances as edge weights.

To link the transport flows with the road network the corresponding transport routes need to be determined. First, every NUTS-3 region is assigned to a network node by calculating the shortest distance between the middle point of a region and all network nodes. These nodes define the start and ending points of each transport route. *NetworkX* provides a variety of different methods for determining an optimal route within the modeled graph. For simplicity, it is assumed that the transport flows always take place on the routes with the shortest distances. For the determination of routes with minimum distances, Dijkstra's algorithm is used. For each O-D pair within the traffic flow matrix, an optimal route is computed in terms of edge and node paths using Dijkstra's algorithm. Since the edge weights of our network refer to distances between node points and thus cannot be negative, the algorithm finds the optimal route in the graph of the road network.

Using the scaled transport flows and the determined optimal routes between NUTS-3 regions, traffic flows on the road network can now be mapped. When assigning trucks to the corresponding roads, it is important to note that regional traffic cannot necessarily all be mapped onto the modeled highway network. Each region is assigned to exactly one network node at which transport routes start and end. If a transport process takes place exclusively within a NUTS-3 region, it cannot be mapped by the highway network because the starting points and destination points correspond. These intra-regional transport processes are also not further specified in the ETISplus data set, therefore an allocation of these transport processes to the road network cannot take place. In addition, all routes defined as regional traffic are excluded from the analysis. Regional traffic includes all routes that do not have a network node within either the origin or destination region and are less than 50 km apart or directly adjacent. The distance of 50 km corresponds to the shortest distance class defined by Transport

and Environment in their analysis of ETISplus data (Transport & Environment 2020).

After removing regional transports, the traffic volumes of the remaining routes are linked to the road network. In this process, the annual number of trucks for each network node and network edge is calculated using the optimal routes of Dijkstra's algorithm. It should be noted that this is a strong abstraction of reality, since in practice the optimal routes are not selected based only on the shortest distance. Traffic would be more divided between the different routes due to congestion, road works or for logistical reasons. The output of the modeling process is a model of European traffic flows, which is used to map and analyze heavy goods traffic in the EU. The entire model generation process of the freight transport flows is shown in figure 3.

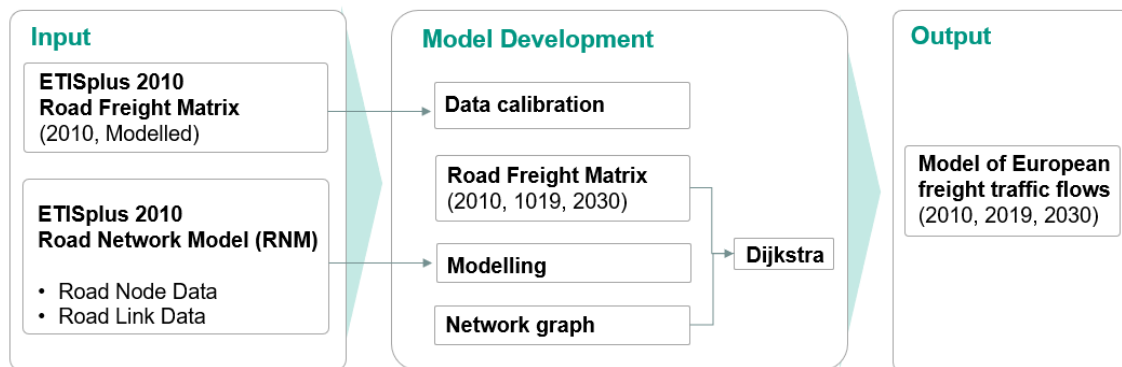

Figure 3: Schematic representation of the model development process

2.2.2 Charging infrastructure model

After modeling the traffic flows for the years 2019 and 2030, possible fast-charging infrastructure is designed based on the created traffic flow model. First, a geographic location distribution is determined using the coverage approach and then the number of charging points for individual locations is calculated using a queuing model.

2.2.3 Coverage approach

To enable a meaningful and systematic procedure for traversing the network graph within the coverage approach, some adjustments have to be made to the network graph. For the following analysis, the network graph is reduced to the core network of E-roads, which was defined by the United Nations Economic

Commission for Europe (United Nation Treaty Series (UNTS) 1975). Besides, the graph is enriched by reducing the maximal length of the road links. Here, all road sections are halved, and a new node is placed until a maximum distance of 10 km is no longer exceeded for any road section.

The procedure within the coverage approach is defined following the model of Plötz et al. (Plötz et al. 2020). Every single road of the network graph is traversed successively according to a predefined scheme. The E-road classification divides the roads into two major groups. The odd numbers indicate roads that run from north to south, whereas the even road numbers run from east to west. Each of these roads is processed one after the other in ascending order, along the previously defined direction of travel. All 21,139 nodes of the enriched network graph are considered as potential locations.

$$(3) CL_S = \begin{cases} 1, & \text{if } d_{CL,L} \geq d_{avg} \\ 0, & \text{else} \end{cases}$$

CL_L charging location at location L

$d_{CL,L}$ distance between the last positioned charging location and location L

d_{avg} defined distance between two charging locations

The decision on whether a node is selected as a location can be made using equation (3). In equation (3) a node is selected as a location if the distance to the next location exceeds the previously defined distance (d_{avg}) of 50 km or 100 km (Plötz et al. 2020). The European road network includes roads in all regions of the European continent and not only within the European Union. Since it is politically and economically very costly to implement a nationwide charging infrastructure for such a large number of countries, Russia, Belarus, Ukraine, and Turkey are excluded from the results below.

2.2.4 Queuing model

The procedure described in this section for modeling a queue system to size the charging locations is carried out following the procedure in Plötz et al. Here, the required number of charging points at each location is determined to achieve an average truck waiting time at the locations of five minutes. In the first step, formula (4) is used to calculate the expected daily charging events for the entire E-road network (Plötz et al. 2020).

$$(4) CE_m = \frac{BET_{share}(ATV_{HDV,M}/313)}{range_{BET}} * CE_{public}$$

| | |
|---------------|---|
| CE_m | daily charging events in model |
| BET_{Share} | share of BET in fleet [%] |
| $ATV_{HDV,M}$ | annual traffic volume of all HDV in model [km] |
| 313 | annual driving days (except Sundays) |
| $range_{BET}$ | assumed mileage in 4,5h [km] |
| CE_{public} | share of charging events on public infrastructure [%] |

Sundays are excluded as annual driving days, since many European countries, such as Germany, France, Greece, and Italy, have a Sunday truck driving ban. It is assumed that the range of the batteries is adapted to the typical driving times of 4.5 h, resulting in a driving distance of 300 km between charging processes. The predicted share of electric vehicles in the vehicle fleet is 5% or 15%, depending on the scenario considered. Another important parameter is the proportion of charging processes that take place at public charging infrastructure. It is assumed that only 25% of the charging processes will take place at the public infrastructure on the E-road network in the model.

Once the amount of expected daily charging events has been calculated, formula (5) is used to allocate the charging processes to the individual charging locations. For this purpose, the maximum traffic volume in the area in front of and behind the location is calculated and compared with the total maximum traffic volume of all locations. The number of trucks in both directions is considered together.

$$(5) CE_{CL_i} = CE_M * \frac{MAX_{CL_{i-1}}^{CL_{i+1}}(TV_j)}{\sum_{CL} MAX_{CL-1}^{CL}(TV_j)}$$

| | |
|-----------------------------------|--|
| CE_{CL_i} | daily charging events at realized charging location i |
| CE_M | daily charging events in model |
| $MAX_{CL_{i-1}}^{CL_{i+1}}(TV_j)$ | maximum daily traffic volume on half the distance between realized charging location i and the realized location before this location (CL_{i-1}) and half the distance to the subsequent location (CL_{i+1}) |
| $\sum_{CL} MAX_{CL-1}^{CL}(TV)$ | sum over the determined maximum daily traffic volumes of the sections of all realized charging locations |

Within the ETISplus data only daily traffic volume can be determined. For the calculation of the exact number of charging points required per charging location, the distribution of the charging processes over the entire day is relevant, which is why further assumptions must be made. For the daily average, an equal distribution over all hours can be assumed which corresponds to 4.2% of the daily traffic volume. For the peak hours, Plötz et al. define a proximity value of 6% of the daily traffic volume. Both values are used for the specification of the queuing model.

In addition, an average waiting time of five minutes is assumed. Together with a charging time of 30 minutes and a buffer of 10 minutes, the 45-minute legally prescribed rest period for drivers is not exceeded in the expected value (Plötz et al. 2020). The scheduled rest periods can thus be optimally utilized for charging the trucks, which can lead to a high acceptance of electric truck solutions.

In the literature on queuing models, a classification code has been established as a distinguishing feature of different problems, which is called Kendall notation after its inventor (Kendall 1953). In the notation six parameters A, B, c, d, k, and m are specified.

- A: probability distribution for arrival process
- B: probability distribution for service process
- C: number of counters
- d: selection rule of next customer
- k: maximum number of customers allowed in the queuing system
- m: maximum number of customers in total

The number of counters is defined by the number of charging points at the corresponding location. For a charging process like it is described in this model, the FIFO principle (First In- First Out) can be assumed as the selection rule for the next customer. The maximum number of customers here refers to the maximum number of trucks in the system. Since these are not constraints for k and m, they can be assumed to be infinite (Plötz et al. 2020).

There are three different possible underlying distributions for the arrival process (Domschke et al. 2015). M stands for Poisson-distributed arrivals and means that the inter-arrival times in the service system are exponentially distributed. G stands for an arbitrary distribution where mean and variance are known, and D describes deterministic arrival times. In this model it is plausible, as also assumed by Plötz et al., that the arrivals are Poisson-distributed. The Poisson distribution is specified by the parameter λ , which represents both the expected

value and the variance (Kamps 2018). In this model, λ is defined as the mean arrival rate of trucks, which is specified by the daily peak or mean traffic.

According to Funke, the probability distribution of the service process can be assumed to be approximately normally distributed (Funke 2018). In this case, the average charging time corresponds to the targeted 30 minutes. The entire queuing process at a charging location can thus be defined as an M/G/c queuing system, following the Kendall notation. For each location, the number of daily charging processes can now be determined using the formula (4) presented earlier.

By considering the previously defined proportions of 6% (peak traffic) and 4.2% (daily average traffic), the average arrival rate λ [truck/hour] is then calculated. An average charging time of 30 min results in an average service rate of $\mu = 2$ [truck/hour]. By additionally specifying the target mean waiting time of five minutes, these parameters are used to make all the necessary assumptions for calculating the minimum required charging points c per site.

There is currently no calculation formula for the waiting times in an M/G/c queuing system, so an approximation formula (formula (6)) is used. This extension of the Pollaczek-Khinchine formula was specified in more detail by Funke and allows an approximation via the average waiting time in an M/M/c system (Funke 2018).

$$(6) W_q^{M|G|c} = \frac{C^2 + 1}{2} W_q^{M|M|c}$$

$W_q^{M|G|c}$ average waiting time in M/G/c system

$W_q^{M|M|c}$ average waiting time in M/M/c system

C variation coefficient of the distribution of service time
(quotient of the standard deviation and the mean value of the service time distribution)

By defining the mean waiting time of five minutes and using the exact results for the mean waiting time of M/M/c systems, this approximation formula can be used to calculate the number of service points. For each location, the minimum number of charging points c is calculated, which are required in order not to exceed the mean waiting time of five minutes.

3 Results

3.1 Traffic flow analysis

In this section, the traffic flows determined in the previous chapter are analyzed in more detail. The aim is to compare the results with existing traffic data to assess the reliability of the forecasts. In doing so, possible errors can be detected and adjustments to the model can be made before infrastructure models are carried out based on the traffic flows.

Figure 4 shows the modeled traffic flows on the network graph, depending on the road utilization.

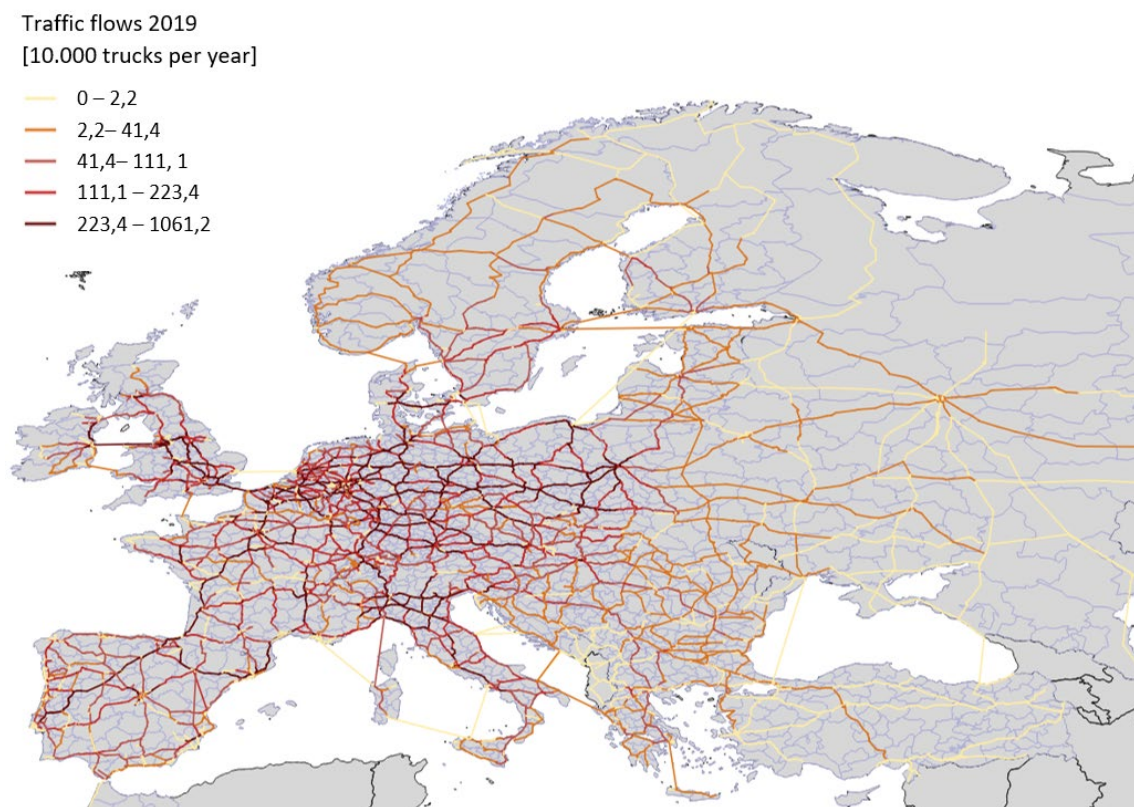

Figure 4: Modelled traffic flows in 2019

To evaluate the determined traffic flows, the data are compared with automated traffic census on German highways from 2018 (BAST 2019). In order to compare the annually counted traffic volumes with the traffic flows of the network graph, the counting stations are assigned to nodes of the road network. Only counting stations are considered that can differentiate between passenger cars and heavy-duty traffic.

Although the distribution of freight traffic is largely consistent in both data sets, the absolute values of the individual nodes calculated in the model deviate significantly from the traffic census. An overview of the relative deviations of the absolute traffic volumes within the individual comparison points is shown in figure 5.

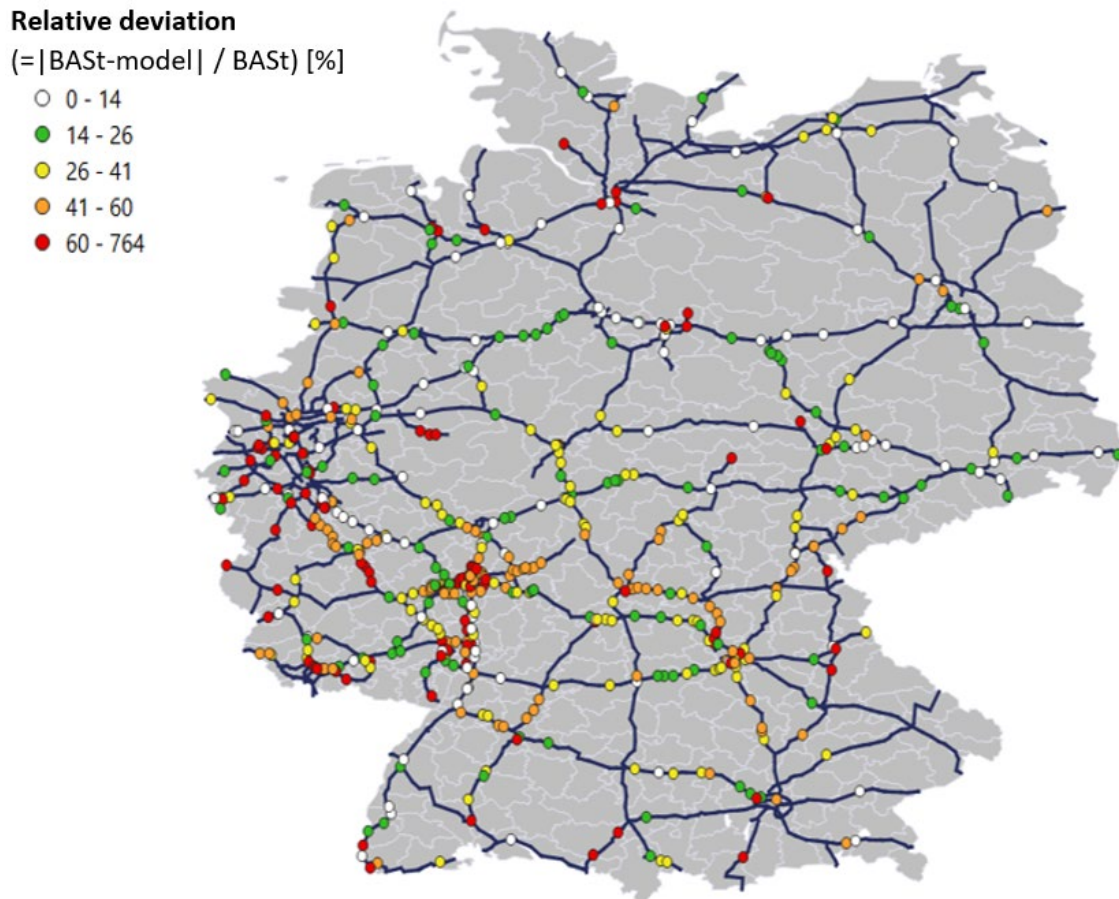

Figure 5: Relative deviation between traffic flows in model and BASt counting data

The average relative deviation is 51% and the median is 37%. In total, the 789 automatic traffic counting stations record 1.39 times as much heavy-duty traffic as modeled in the assigned intersections based on the ETISplus data for the year 2019. In the following section possible reasons for the differences will be analyzed.

The data basis in ETISplus does not provide information on traffic flows within a NUTS-3 region. However, intra-regional transports play a significant role in road transport. In Germany, they account for 31% of transports within the ETISplus

data set in terms of transport volume. It can be assumed that a part of the intra-regional transports also takes place on the highways. Especially in regions with a comprehensive highway network, people use existing highways even for short distances. This can be seen in the fact that highways that are primarily used for long-distance traffic, such as the A2 going from the Ruhr region to Berlin, have lower deviations (10%) than, for example, the A8 going through urban areas like Stuttgart, Karlsruhe or Munich (48%), which is also used for regional traffic. Due to the different distribution of the deviations and the high share of intra-regional traffic, it is obvious that a part of the deviations can be explained by the lack of intra-regional traffic flows.

The average loading factor in Eurostat refers to transports of loaded trucks and the route calculation refers to transported freight volumes, which is why empty runs are not considered in the model evaluation so far. The average percentage of empty runs within the EU-27 countries was 20% of heavy goods transport in 2018. This can explain a difference factor of 1.25 between the model and BASt data. Empty runs are therefore a major contributor to the discrepancies within the measured values.

The exact extent of the deviations due to regional traffic and the distorting influence of the route optimization by the Dijkstra algorithm cannot be quantified concretely. The adjustment of the traffic flows in the model therefore only takes place based on the missing empty runs. The modeled number of trucks for each section is scaled with the value of 1.25 determined from the EU average.

3.2 Charging infrastructure networks

For the following analysis, different framework conditions are defined for a total of three scenarios. The final results of all scenarios refer to the year 2030. The first distinguishing feature of the different scenarios is the geographical location distribution. Here, a distinction is made between high station coverage with a target distance between charging stations of 50 km and lower station coverage with a target distance of 100 km. The second differentiating feature is the projected share of electric trucks within the European truck fleet in 2030. A distinction is made between a minimum diffusion level of 5% BEV and a medium penetration of 15% BEV.

In the scenario "wide-meshed network" a share of 5% BEV and a coverage of 100 km and in the "close meshed network" a scenario with 15% BEV and a charging location every 50 km is analyzed. In addition, a scenario with a startup

network for the year 2025 and an expansion network for the year 2030 is calculated. This scenario "startup and expansion network" is in line with the targets demanded by the industry, where a startup network with charging locations every 100 km until 2025 and an expansion network every 50 km until 2030 are required (Transport & Environment 2021). An overview of the three scenarios can be found in figure 6.

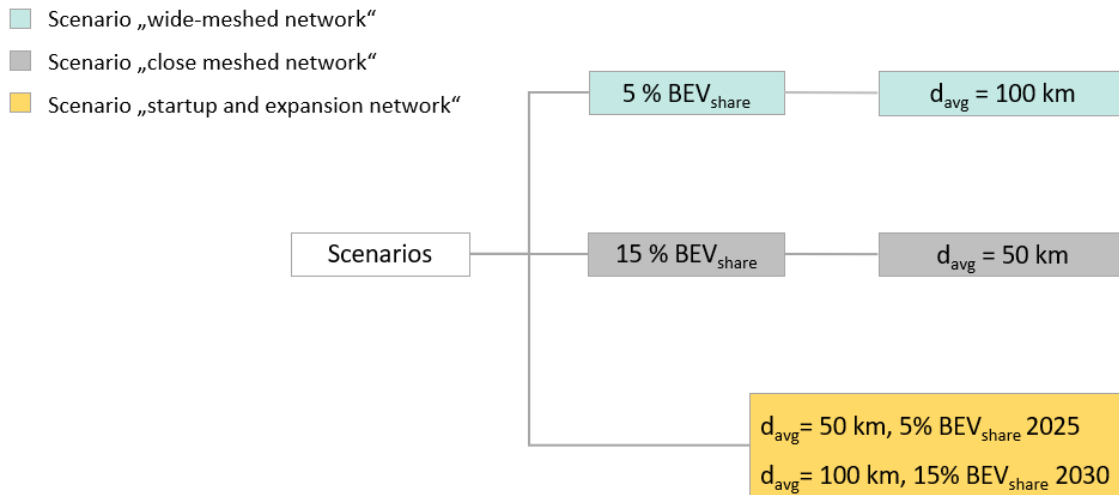

Figure 6: Overview of the considered scenarios

The coverage approach is performed once for a targeted distance of $d_{avg} = 100$ km and once for $d_{avg} = 50$ km. For a targeted average distance of 100 km, 812 potential locations and for the 50 km network, 1,640 locations are identified.

In the “wide-meshed network”, the median distance of a fast-charging station to the nearest station is 93 km. In the worst case, the nearest fast-charging station is 164 km away from the current station. High distances occur when two roads merge into each other, thus interrupting the distance calculation. On average, the coverage approach allows the next fast-charging station to be reached within the targeted 100 km, but longer distances can be covered without encountering a location due to the change between the individual roads. This evaluation is of particular interest to logistics companies, as it allows them to determine the worst-case distances that can be traveled without reaching a recharging location. The maximum distance that can be driven within the network starting from a charging station without encountering another potential station is 118 km on average. This value shows that regardless of the selected route, the next location can be reached without detours within the desired distance of 100 km in most cases.

When considering the entire road network in the "close meshed network", the distance to the nearest location is 50.79 km in the median and 84 km in the worst case. The maximum drivable distance of a route on the entire road network starting from a charging location without encountering another station is 297 km but only 59 km at the median. The coverage analysis performed here shows that in most cases a station can be reached within the target distance of 50 km.

Within the "startup and expansion network" scenario, the coverage approach is executed successively. In determining the startup network, stations are calculated using the coverage approach with a target distance of $d_{avg} = 100$ km. The startup network thus corresponds to the "wide-meshed network" already presented. Subsequently, all previously positioned stations are considered for the expansion network and additional stations are placed in the intermediate spaces with a distance of 50 km. This does not create a completely new network of proposed fast-charging locations, but rather adds additional locations to the old network. A total of 1,719 locations are determined in the process. The results of the coverage approach can be found in figure 7.

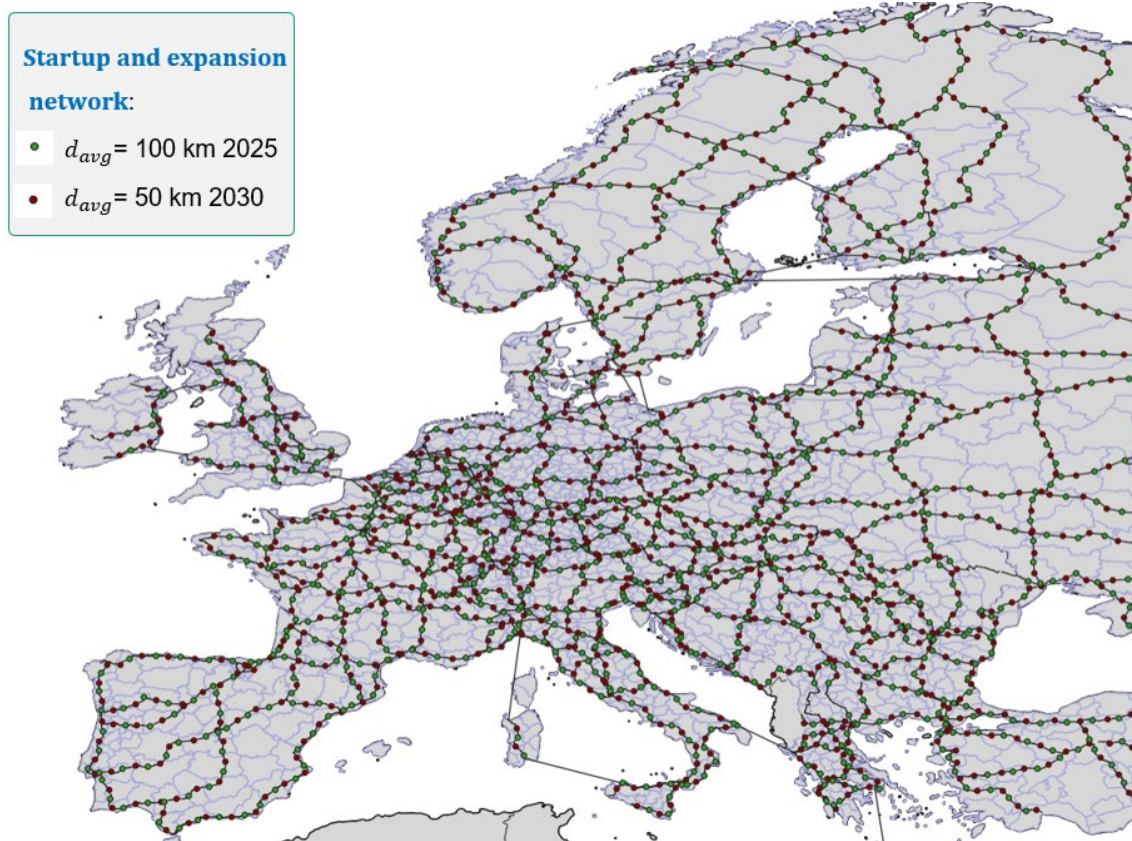

Figure 7: Coverage approach of the "startup and expansion network"

For the European road network, figure 8 shows the result of the coverage approach with subsequent dimensioning in the "wide-meshed network". The queuing model determined a total of 1,715 charging points at 812 locations in this scenario. Road sections with high traffic volumes stand out due to locations with many charging points. Because of the low share of BEV (5%), a maximum of 14 charging points are modeled at one location on the busiest road sections, but at least one charging point is placed at each location.

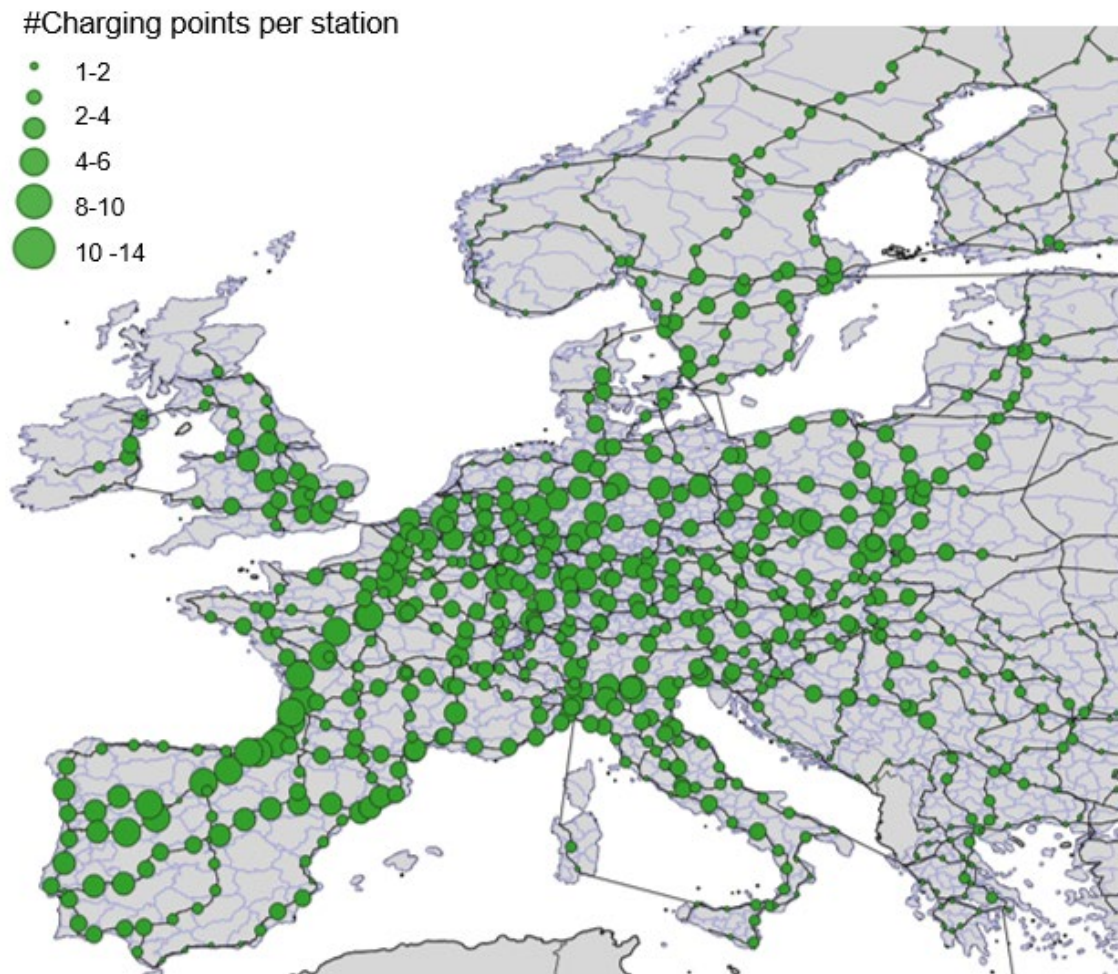

Figure 8: Distribution and size of fast-charging stations in the “wide-meshed network”

In contrast, figure 9 shows the location distribution and dimensioning in the “close meshed network”. A denser coverage with a target distance of 50 km between charging points results in a total of 4,067 charging points at 1,640 locations. Due to the higher share of BEV of 15%, significantly larger charging locations are created with up to 37 charging points at one location, which are also placed on the busiest routes of the model.

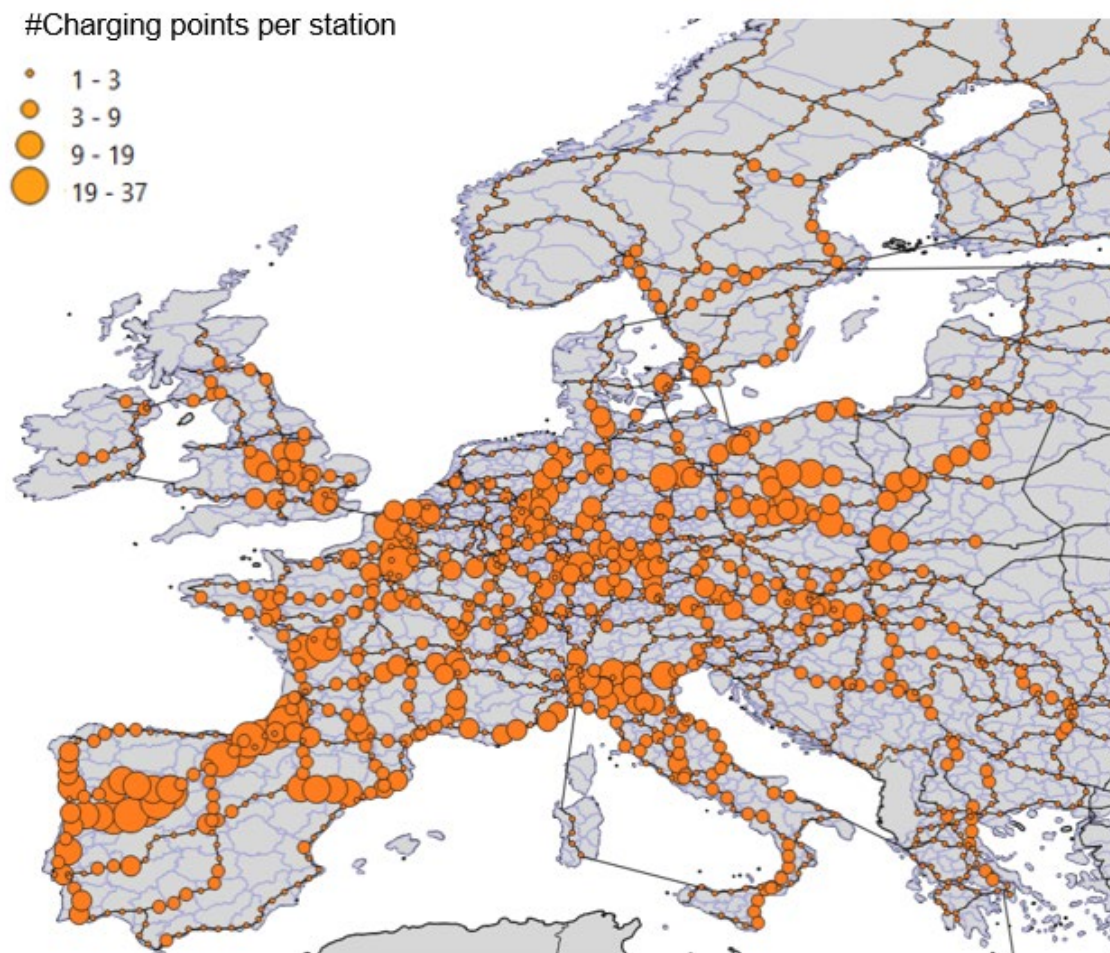

Figure 9: Distribution and size of fast-charging stations in the “close mesh network”

The evaluation of individual European countries and their charging location distribution in the model provides insights into regional differences. In countries with a high volume of traffic, such as Germany, Spain or France, higher average values can be observed than the overall European average of 3.1 charging points per location. For example, the average number of charging points per location in France is 4.5, in Spain 5.8 and in Germany even 7.1. For Norway and Sweden, on the other hand, only 1.2 and 2 charging points per location are modeled.

For the startup network within the “startup and expansion network”, the queuing model is calculated based on the annual mileage forecast for the year 2025. A share of 5% BEV is assumed. To meet the resulting charging demand, a total of 1,819 charging points is required. These charging points are distributed across 812 locations in the EU-wide network. In the median, there are two charging

points at one location in the startup network, with a maximum of 11 points and at least one charging point per location.

In the expansion network for 2030 that follows the startup network, a total of 5,112 charging points are planned at 1,719 locations. Here, the annual mileage in 2030 with a share of BEV of 15% serves as the database. On average, there are 2.9 charging points at a location and the median is two charging points per location. These values are very similar to the results of the previously described “closed-meshed network” with a mean value of 3.1 charging points per location and a median of also two charging points per location. Since a network expansion with an adjusted dimensioning takes place within the “startup and expansion network”, the number of charging points placed at one station considered at both, the startup and the expansion network, changes. At 39% of the old locations in the startup network, additional charging points are built and 19% remain unchanged. At 29% of the locations, the number of required charging points is reduced by the addition of new charging locations within the expansion network. In more than 70% of the cases, however, the demand is reduced by only one charging point per location. The analysis shows that the expansion of the startup network can be realized from the already existing infrastructure in the startup network by adapting the old locations and building new stations.

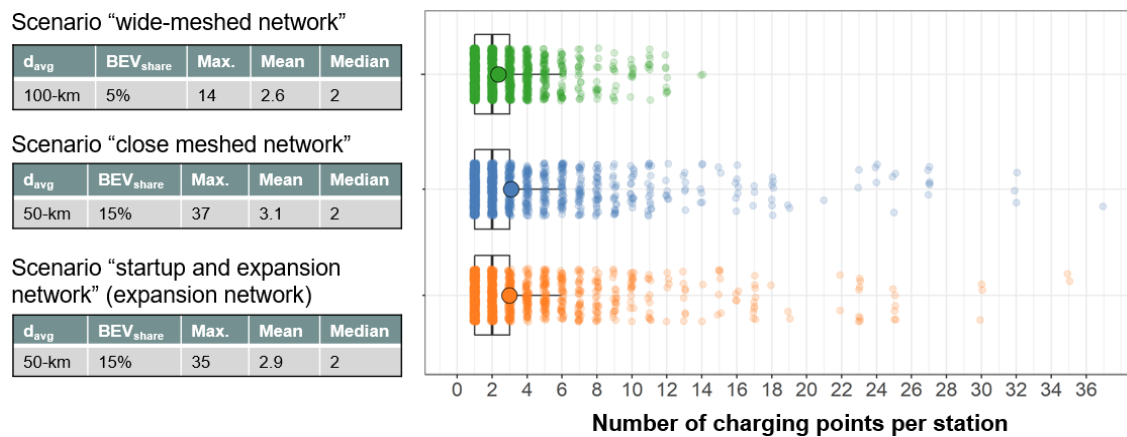

Figure 10: Comparison of the distribution of charging points per location

Finally, figure 10 provides an overview of the distribution of charging points among the locations in the scenarios discussed. In the comparison of the “close meshed network” and “wide-meshed network” scenarios, the maximum number of charging points at a location differs. This amounts to 14 locations within the “wide-meshed network” and 37 locations within the “close meshed network” when covering the peak hours. However, the median values are the same with

two charging points per site and the mean values of 2.6 and 3.1 are also close. Mainly responsible for the different maximum values are the modeled shares of BEV in the scenarios. In the “close meshed network” scenario, a significantly larger charging demand has to be covered with a share of 15% BEV.

The distribution of the locations in the “startup and expansion network” scenarios is similar to that of the “close meshed network” and the “wide-meshed network”, as they only differ in terms of the expansion dates and the coverage approach. Although the maximum number of charging points and the dispersion of the extreme values differ in the various scenarios, the median is constant at two charging points per location and the average values differ by a maximum of one charging point per location.

4 Discussion

The charging infrastructure proposals derived in this paper were modeled considering some assumptions and simplifications. A large part of the limitations results from the limited nature of the ETISplus dataset. Especially when scaling the data and transferring the traffic to the road network, these limitations become obvious. Due to the lack of up-to-date data, the transport volumes from 2010 given in the ETISplus dataset were scaled to the years 2019 and 2030 using modeled growth rates. There are no Eurostat tables available at NUTS-3 level, which is why several Eurostat tables had to be aggregated together. Although the comparison with growth rates of other forecasts showed that the Europe-wide development of transport growth can be well met, the modeling of constant growth rates until 2030 represents a simplification.

In addition to this, a close examination of the scaling shows that for Portugal the growth for 2030 has been overestimated in the model. This has no influence on the general statement of the results, but it can be assumed that the Portuguese transports, especially between Portugal, Spain, and France, were overestimated by 10% to 20%.

The allocation of the transport volumes to the road network using Dijkstra's algorithm also results in a strong simplification of the traffic distribution on the roads. It is assumed that the route selection of freight traffic is made solely based on route length, whereas for logistics companies additional factors such as congestion, route closures and routes with multiple stops play a role. Furthermore, the ETISplus dataset does not allow mapping intra-regional transports within a NUTS-3 region and thus underestimates the traffic volume in certain areas. However, the comparison of the traffic flows with the existing census traffic data on the German highways show that the model matches many road utilizations well.

Since the traffic is modeled in an undirected manner, both directions of travel have been considered together for determining the number of charging points per station. In addition, when interpreting the charging infrastructure models, it is important to note that they cannot be directly interpreted as coordinately accurate location proposals, but rather call for a location in the appropriate road segment. Although the results provide a possible scenario for network expansion over several time horizons within the start and expansion network scenario, no market ramp-up model or exact expansion sequence can be derived from them.

5 Conclusion and outlook

A dense fast-charging infrastructure is essential for the successful electrification of road freight transport. To achieve the targeted climate neutrality of the EU and to meet the demands of the automotive industry, concrete and near-time expansion plans are needed. The present study developed a coverage model for a European network of fast-charging infrastructure for electric trucks. Despite the existing limitations, the model provides guideline values for the infrastructure design, which have been lacking in the literature so far.

Factors relevant for the realization of charging locations, such as the existence of sufficient parking facilities or the connection to the power grid, were not considered within the model. The subject of further research would have to be the design of the concrete market ramp-up of such a charging infrastructure. Initially, busy routes, for example between large ports and industrial areas, could be equipped with charging stations. A subsequent step-by-step development, as described in the “start-up and expansion network” scenario, would lead to a nationwide network. Further supplementary studies would have to be carried out in order to be able to define country-specific expansion targets.

Although the data of the ETISplus project prepared here provide insights into the traffic structures of the European road network, the modeling difficulties encountered make it clear how urgently more precise and up-to-date data sets are needed for the successful implementation of future research projects. All stakeholders from politics, research and industry have to work together to provide the necessary traffic flow data.

Uncertainty about future technical developments, such as charging time and range, as well as political demands pose additional challenges for infrastructure forecasts. In addition to supporting the provision of comprehensive traffic data, it is the task of politics to adapt the expansion plans of the European charging infrastructure to the ambitious climate targets in the upcoming revision of the current EU directive (AIFD). The planning security for logistics companies and automobile manufacturers achieved through a nationwide charging infrastructure will determine the speed at which battery-electric drives will become established in freight transport.

6 References

- ACEA (2020): ACEA Policy Paper Road freight transport ACEA Policy Paper: Road freight transport on the way to carbon neutrality. Online verfügbar unter https://acea.be/uploads/press_releases_files/ACEA_Policy_Paper-Road_freight_transport_on_the_way_to_carbon_neutrality.pdf.
- ACEA; Transport & Environment (2021): Making AFID fit for zero-emission heavy-duty vehicles. Online verfügbar unter https://www.transportenvironment.org/sites/te/files/publications/2021_04_letter_TE_ACEA_trucks_AFID_FINAL.pdf.
- BAST (2019): Automatische Zählstellen 2018. Online verfügbar unter https://www.bast.de/BAST_2017/DE/Verkehrstechnik/Fachthemen/v2-verkehrszaehlung/Aktuell/zaehl_aktuell_node.html.
- Ben Ticha, Hamza; Absi, Nabil; Feillet, Dominique; Quilliot, Alain (2017): Empirical analysis for the VRPTW with a multigraph representation for the road network. In: *Computers & Operations Research* 88, S. 103–116. DOI: 10.1016/j.cor.2017.06.024.
- Domschke, Wolfgang; Drexl, Andreas; Klein, Robert; Scholl, Armin (2015): Einführung in Operations Research: Springer Gabler.
- ETISplus (2012a): etis_2010_modelled.zip.002. Online verfügbar unter <https://ftp.demis.nl/outgoing/etisplus/datadeliverables/TextFiles>.
- ETISplus (2012b): Land_networks_2010. Online verfügbar unter <https://ftp.demis.nl/outgoing/etisplus/datadeliverables/Additional/>.
- Europäische Kommission (2020): Fragen und Antworten: Strategie für nachhaltige und intelligente Mobilität. Online verfügbar unter https://ec.europa.eu/commission/presscorner/detail/de/QANDA_20_2330.
- Europäische Kommission (2021): Bericht der Kommission an das Europäische Parlament und den Rat über die Anwendung der Richtlinie 2014/94/EU über den Aufbau der Infrastruktur für alternative Kraftstoffe. Online verfügbar unter <https://eur-lex.europa.eu/legal-content/DE/TXT/PDF/?uri=CELEX:52021DC0103&from=EN>.
- European Commission (2011): Road Freight Transport Vademecum 2010 Report. Market trends and structure of the road haulage sector in the EU in 2010. Online verfügbar unter

- <https://ec.europa.eu/transport/sites/transport/files/modes/road/doc/2010-road-freight-vademecum.pdf>.
- European Commission (2013): European Transport policy Information System Development and implementation of data collection methodology for EU transport modelling. Online verfügbar unter <https://cordis.europa.eu/project/id/233596>, zuletzt aktualisiert am 001.08.2019, zuletzt geprüft am 20.01.2021.
- Eurostat (2014): Statistics Explained. Glossary: Cabotage. Online verfügbar unter <https://ec.europa.eu/eurostat/statistics-explained/index.php?title=Glossary:Cabotage>, zuletzt aktualisiert am 05.12.2014, zuletzt geprüft am 05.01.2021.
- Eurostat (2020a): Transport Database. Online verfügbar unter <https://ec.europa.eu/eurostat/web/transport/data/database>, zuletzt geprüft am 13.04.21.
- Eurostat (Hg.) (2020b): Treibhausgasemissionen nach Quellsektor. Online verfügbar unter https://ec.europa.eu/eurostat/databrowser/view/ENV_AIR_GGE__custom_67265/bookmark/table?lang=de&bookmarkId=f364c997-e725-45ed-b71e-0db346105a4a, zuletzt aktualisiert am 27.12.2020.
- Funke, Simon (2018): Techno-ökonomische Gesamtbewertung heterogener Maßnahmen zur Verlängerung der Tagesreichweite von batterieelektrischen Fahrzeugen. Dissertation an der Universität Kassel.
- Hüpen, Rolf (2002): Zur Berechnung von Wachstumsraten in diskreter Zeit. Hg. v. Universität Bochum. Online verfügbar unter <https://www.ruhr-uni-bochum.de/wista/download/Beilagen/Wachstumsraten.pdf>.
- Jochem, Patrick; Szimba, Eckhard; Reuter-Oppermann, Melanie (2019): How many fast-charging stations do we need along European highways? In: *Transportation Research Part D*, S. 120–129. DOI: 10.1016/j.trd.2019.06.005.
- Kamps, Udo (2018): Poissonverteilung. Hg. v. Gabler Wirtschaftslexikon. Online verfügbar unter <https://wirtschaftslexikon.gabler.de/definition/poissonverteilung-42305/version-265656>, zuletzt aktualisiert am 16.02.2018, zuletzt geprüft am 27.03.2021.

- Kunith, Alexander; Mendeleevitch, Roman; Goehlich, Dietmar (2017): Electrification of a city bus network—An optimization model for cost-effective placing of charging infrastructure and battery sizing of fast-charging electric bus systems. In: *International Journal of Sustainable Transportation* 11 (10), S. 707–720. DOI: 10.1080/15568318.2017.1310962.
- Li, Shanjun; Tong, Lang; Xing, Jianwei; Zhou, Yiyi (2017): The Market for Electric Vehicles: Indirect Network Effects and Policy Design. In: *Journal of the Association of Environmental and Resource Economists* 4 (1), S. 89–133. DOI: 10.1086/689702.
- Liang, Hao; Sharma, Isha; Zhuang, Weihua; Bhattacharya, Kankar (2014): Plug-in Electric Vehicle Charging Demand Estimation based on Queueing Network Analysis. In: *IEE*.
- Madina, Carlos; Zamora, Inmaculada; Zabala, Eduardo (2016): Methodology for assessing electric vehicle charging infrastructure business models. In: *Energy Policy* 89, S. 284–293. DOI: 10.1016/j.enpol.2015.12.007.
- Morrissey, Patrick; Weldon, Peter; O’Mahony, Margaret (2016): Future standard and fast charging infrastructure planning: An analysis of electric vehicle charging behaviour. In: *Energy Policy* 89, S. 257–270. DOI: 10.1016/j.enpol.2015.12.001.
- Nykvist, Björn; Olsson, Olle (2021): The feasibility of heavy battery electric trucks. In: *Joule* 5 (4), S. 901–913. DOI: 10.1016/j.joule.2021.03.007.
- Plötz, Patrick; Speth, Daniel; Rose, Phillipp (2020): Hochleistungsschnellladernetz für Elektro-Lkw. Kurzstudie.
- Plötz, Patrick; Wachsmuth, Jakob; Gnann, Till; Neuner, Felix; Speth, Daniel; Steffen, Link (2021): Net-zero-carbon transport in Europe until 2050. Targets, technologies and policies for a long-term EU strategy. Online verfügbar unter https://www.isi.fraunhofer.de/content/dam/isi/dokumente/cce/2021/EU_Transport_policybrief_short.pdf.
- Reuter-Oppermann, Melanie; Funke, Simon; Jochem, Patrick; Graf, Felix (2017): How Many Fast Charging Stations Do We Need Along the German Highway Network? Hg. v. Conference: Electric Vehicle Symposium 30 (EVS30).
- Statistisches Bundesamt (2021): NUTS-Klassifikation. Die Einteilung der Europäischen Union in EU-Regionen. Online verfügbar unter

- https://www.destatis.de/Europa/DE/Methoden-Metadaten/Klassifikationen/UebersichtKlassifikationen_NUTS.html, zuletzt geprüft am 15.01.201.
- Szimba, Eckhard; Kraft, Markus; Ihrig, Jan; Schimke, Antje; Schnell, Oliver; Kawabata, Yuko et al. (2012): ETISplus Database Content and Methodology.
- Teoh, Tharsis; Kunze, Oliver; Teo, Chee-Chong; Wong, Yiik Diew (2018): Decarbonisation of Urban Freight Transport Using Electric Vehicles and Opportunity Charging. In: *Sustainability* 10 (9), S. 3258. DOI: 10.3390/su10093258.
- Transport & Environment (2020): Unlocking electric trucking in the EU: recharging in cities. Electrification of urban and regional deliveries.
- Transport & Environment (2021): Die Dekarbonisierung des Lkw-Fernverkehrs in Deutschland. Ein Vergleich der verfügbaren Antriebstechnologien und ihrer Kosten.
- TRT (2020): TRIMODE -Transport Integrated Model for Europe. Online verfügbar unter http://www.trt.it/en/PROGETTI/trimode_project/.
- United Nation Treaty Series (UNTS) (Hg.) (1975): European Agreement on main international traffic arteries (AGR). (with annexes and list of roads). Concluded at Geneva on 15 November 1975. Online verfügbar unter <https://treaties.un.org/doc/Publication/UNTS/Volume%201302/volume-1302-I-21618-English.pdf>.
- Wang, Xiumin; Yuen, Chau; Hassan, Naveed Ul; An, Ning; Wu, Weiwei (2017): Electric Vehicle Charging Station Placement for Urban Public Bus Systems. In: *IEEE Trans. Intell. Transport. Syst.* 18 (1), S. 128–139. DOI: 10.1109/TITS.2016.2563166.
- Xylia, Maria; Leduc, Sylvain; Patrizio, Piera; Kraxner, Florian; Silveira, Semida (2017): Locating charging infrastructure for electric buses in Stockholm. In: *Transportation Research Part C: Emerging Technologies* 78, S. 183–200. DOI: 10.1016/j.trc.2017.03.005.
- Zhu, Zhihong; Gao, Ziyou; Zheng, Jianfeng; Du, Haoming (2018): Charging Station Planning for plug-In Electric Vehicles. In: *Journal of Systems Science and Systems Engineering*.



Authors' affiliations

Verena Sauter, Daniel Speth, Patrick Plötz, Tim Signer

Fraunhofer Institute for Systems and Innovation Research (Fraunhofer ISI)
Competence Center Energy Technology and Energy Systems

Contact: Daniel Speth

Fraunhofer Institute for Systems
and Innovation Research (Fraunhofer ISI)
Breslauer Strasse 48
76139 Karlsruhe
Germany
Phone: +49 721 6809-243
E-Mail: daniel.speth@isi.fraunhofer.de
www.isi.fraunhofer.de

Karlsruhe 2021